

# mirage<sup>®</sup> display

## Centro Modular Display Stands



Modular Displays



AV Displays



Self-build Stands

We have a policy of continuous development and in the interest of clients, reserves the right to change specifications or design and to supply products which may differ from those described and illustrated without notice or liability.

Terms and Conditions are available on our web site [www.eurostanddisplay.com](http://www.eurostanddisplay.com)

All graphics shown are for illustrative purposes only.

# Contents

Modular Displays .....	4	Centro 3 .....	11	Audio Visual Displays .....	20
Centro RotrLink Connections .....	6	Centro Display Pod .....	12	Self-build Exhibition Stands .....	24
Centro 1 .....	8	Centro Poster Display Systems .....	14	Self-build Exhibition Stands Examples .....	26
Centro 2 Straight .....	9	Centro Slatwall .....	16		
Centro 2 Curved .....	10	Centro Accessories .....	18		

# Centro Modular Displays

*Flexible, fast and simple to set up with a premium look*

Our range of modular displays offer premium design display solutions, ideal for showcasing a brand and its messaging in almost any environment. Flexible, cost-effective and easy to set up, these versatile displays can be added to at any time to make larger stands, meaning that a single display can grow as a company's needs change.

Displays are easily transportable and can be used at exhibitions and events, reception and foyer areas, museums, retail environments and many more locations. In contrast to similar modular displays on the market, the range features our new RotrLink 'twist and lock' technology making the setup process quick, fast and simple.

The range features curved and straight displays which can hold both rigid and flexible graphic panels, with everything packing away neatly into wheeled trolley cases at the end of the day. Available accessories include a choice of coloured podium tables, counter units, shelving options, brochure holders, slat wall panels, screen mountings, lighting options and even door units. All displays have a choice of coloured acrylic tops to match any main branding colour and, as always, the entire range is covered by our 5 year guarantee.

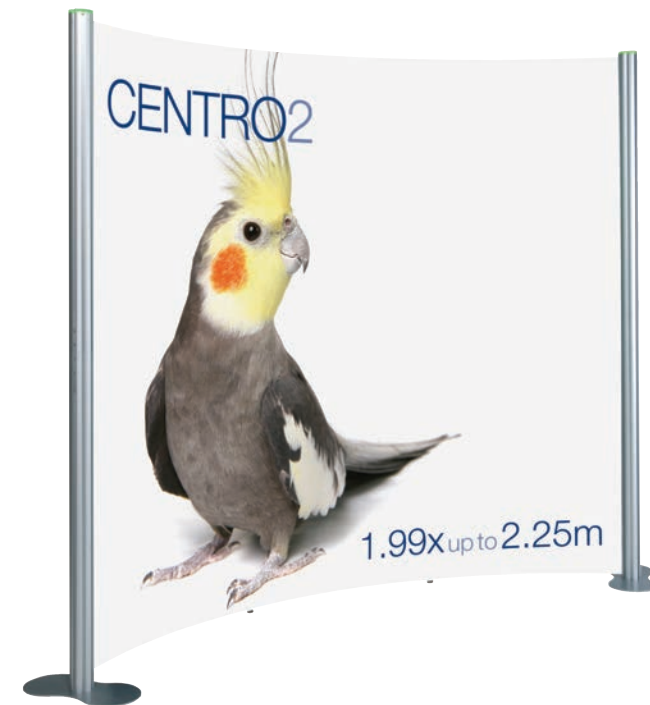



Babycare TENS



For labour  
and beyond

*body clock*

TENS is the natural choice  
for pain relief without drugs

[www.bodyclock.co.uk](http://www.bodyclock.co.uk)

Body Clock TENS: Drug-free pain relief

Tel: +44 (0)208 532 9595 [www.bodyclock.co.uk](http://www.bodyclock.co.uk)

*body clock*



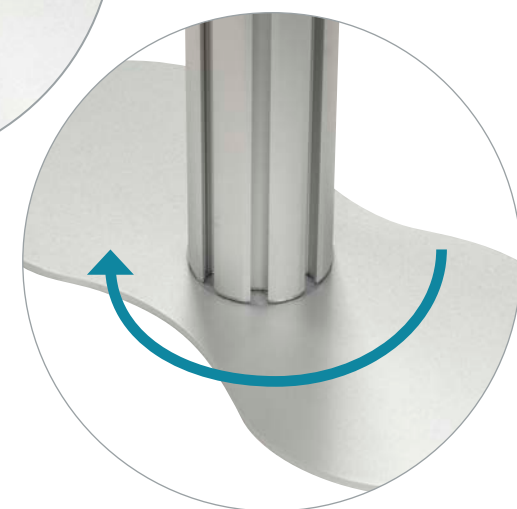
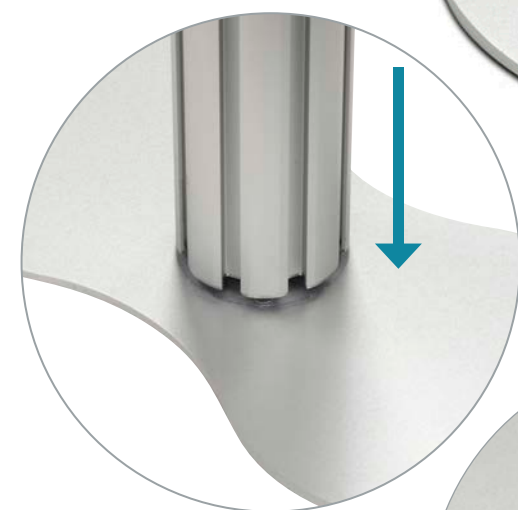

# Centro RotrLink Connections

## Centro RotrLink

The Centro RotrLink twist and lock technology allows fast and easy installation, providing clients peace of mind that they will be able to build small or large modular displays with ease

New unique and innovative RotrLink modular display system maintains the strength of the product whilst dramatically reducing assembly time

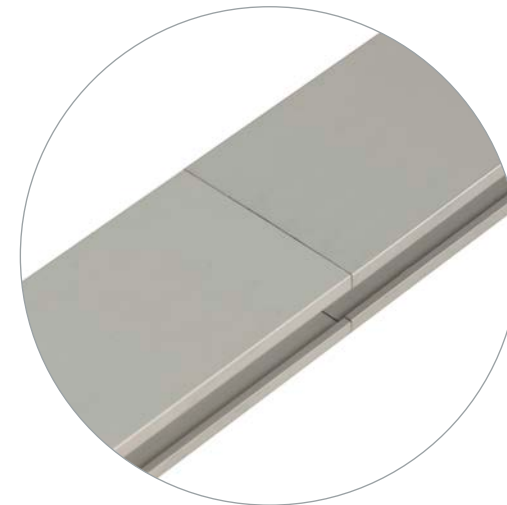
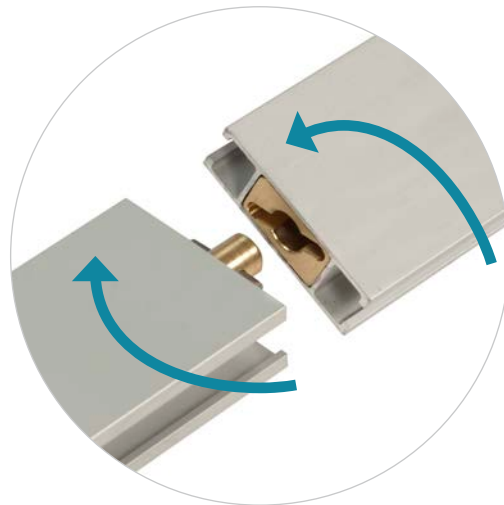
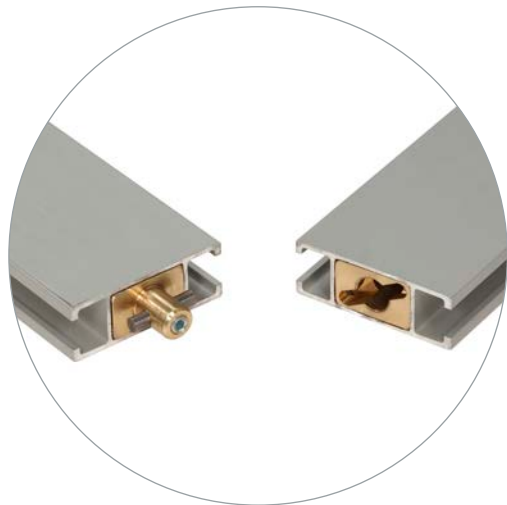
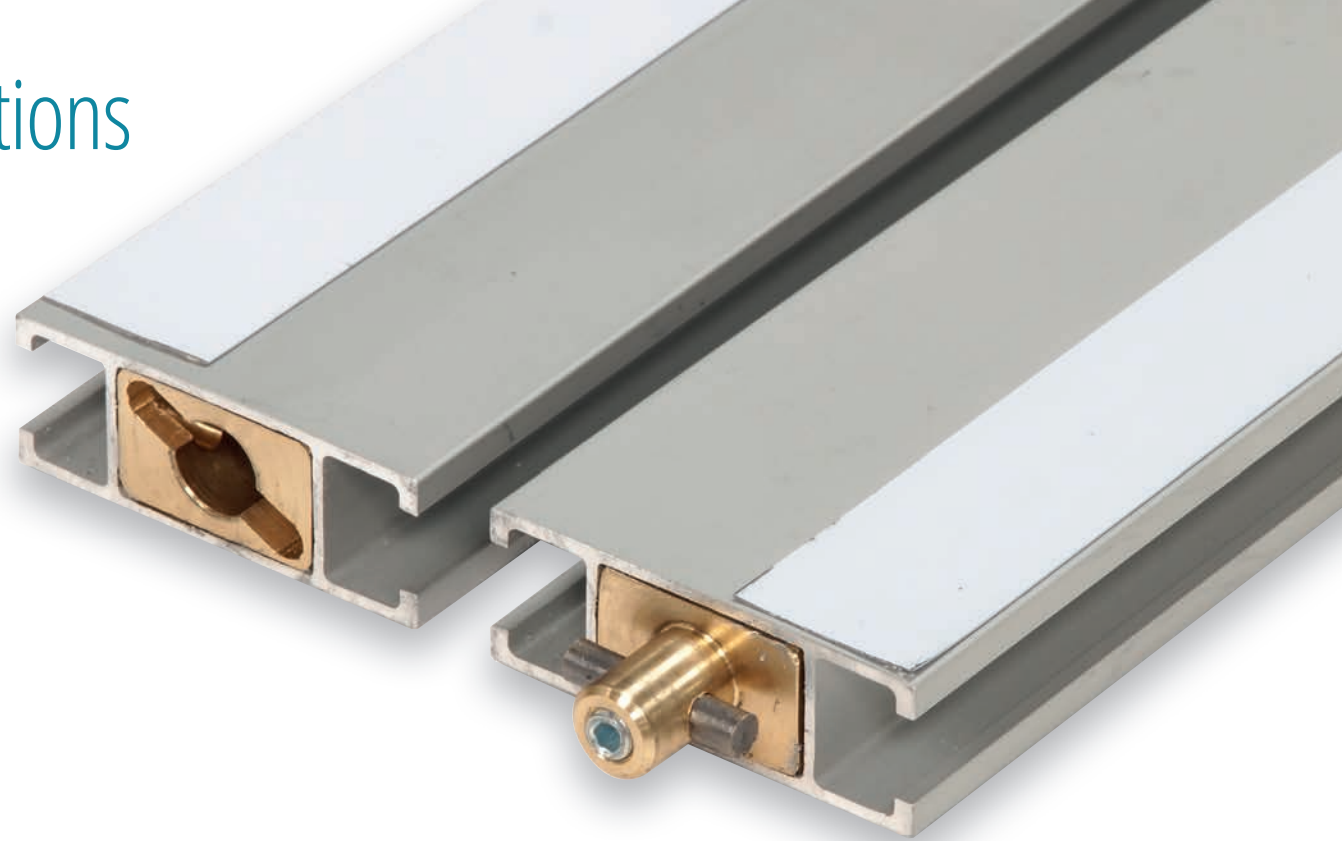

# Centro Modular Displays

Printed 5mm rigid panel

Printed banner material



750mm  
(C1RK/75)



1500mm  
(C1RK/150)



2250mm  
(C1RK/225)



Standard kits - dimensions stated are visible graphic widths for rigid panel graphics

Coloured acrylic features, neon blue, red and green or frost.



## Centro 1

- New unique and innovative RotrLink modular display system
- Substantially reduced assembly time
- Suitable for rigid PVC panel or banner media with horizontal pockets
- Robust anodised aluminium 8-way posts and unique silver steel bases

- Range of coloured contemporary acrylic post caps and accessories
- Standard overall height without lighting 2021mm
- Maximum footprint
  - 750mm - 1006(w) x 380mm(d)
  - 1500mm - 1756(w) x 380mm(d)
  - 2250mm - 2506(w) x 380mm(d)

## Accessories Available

- Curved counter kit - white top only
- Podium set - table top colour to match post cap
- Brochure holder set - colour to match post cap
- Screen monitor and iPad mounting kits
- Choice of 50w or 150w lighting for rigid panel display
- CHLC light bracket required for banner graphic display - 150w light

## Centro Wheeled Trolley Case

- Display hardware for both options fit within single trolley case
- Graphic tube within trolley case can only accommodate banner graphic



CHLC bracket





### RotrLink System

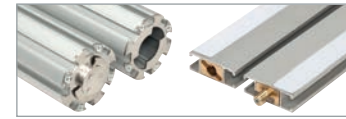

750mm  
(C2RKS/75)

1500mm  
(C2RKS/150)

2250mm  
(C2RKS/225)



Standard kits - dimensions stated are visible graphic widths

Coloured acrylic features, neon blue, red and green or frost.



### Centro 2 straight

- New unique and innovative RotrLink modular display system
- Substantially reduced assembly time
- Suitable for single or double-sided seamless magnetic graphic panel drop(s)
- Robust anodised aluminium 8-way posts and unique silver steel bases

- Range of coloured contemporary acrylic post caps and accessories
- Standard overall height without lighting 2021mm
- Maximum footprint with optional space bars
  - 750mm - 1226(w) x 380mm(d)
  - 1500mm - 1976(w) x 380mm(d)
  - 2250mm - 2726(w) x 380mm(d)

### Accessories Available

- Curved counter kit - white top only
- Podium set - table top colour to match post cap
- Brochure holder set - colour to match post cap
- Screen monitor and iPad mounting kits
- Choice of 50w or 150w lighting
- Optional spacer bar kit

### Centro Wheeled Trolley Case

- Display hardware and graphics fit within single trolley case



# Centro Modular Displays



750mm  
(C2RKC/75)



1500mm  
(C2RKC/150)



2250mm  
(C2RKC/225)



Standard kits - dimensions stated are visible graphic widths

Coloured acrylic features, neon blue, red and green or frost.



## Centro Wheeled Trolley Case

- Display hardware and graphics fit within single trolley case



## Centro 2 curved

- New unique and innovative RotrLink modular display system
- Substantially reduced assembly time
- Suitable for single or double-sided seamless magnetic graphic panel drop(s)
- Robust anodised aluminium 8-way posts and unique silver steel bases

- Range of coloured contemporary acrylic post caps and accessories
- Standard overall height without lighting 2021mm
- Maximum footprint with optional space bars
  - 750mm - 1263(w) x 378mm(d)
  - 1500mm - 2007(w) x 393mm(d)
  - 2250mm - 2695(w) x 567mm(d)

## Accessories Available

- Curved counter kit - white top only
- Podium set - table top colour to match post cap
- Brochure holder set - colour to match post cap
- Screen monitor and iPad mounting kits
- Choice of 50w or 150w lighting
- Optional spacer bar kit



Without spacer bars

CENTRO3

CENTRO3

1.99x.75m

1.99x.75m

### Centro 3

- New unique and innovative RotrLink modular display system
- Substantially reduced assembly time
- Suitable for single or double-sided seamless magnetic graphic panel drop(s)
- Robust anodised aluminium 8-way posts and unique silver steel bases
- Range of coloured contemporary acrylic post caps and accessories
- Standard overall height without lighting 2021mm
- Maximum footprint
  - 750mm (1 x 750mm) - 1226(w) x 380mm(d)
  - 1500mm (2 x 750mm) - 2269(w) x 380mm(d)
  - 2250mm (3 x 750mm) - 3312(w) x 380mm(d)



RotrLink System

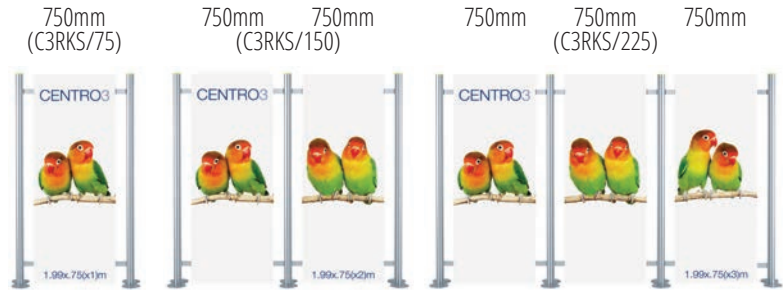

Standard kits (dimensions stated are visible graphic widths)

Coloured acrylic features, neon blue, red and green or frost.

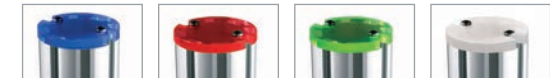

### Centro Wheeled Trolley Case

- Display hardware and graphics for C3RKS/75 fit within single trolley case
- Display hardware and graphics for C3RKS/150 & C3RKS/225 requires two trolley cases



### Accessories Available

- Curved counter kit - white top only
- Podium set - table top colour to match post cap
- Brochure holder set - colour to match post cap
- Screen monitor and iPad mounting kits
- Choice of 50w or 150w lighting

# Centro Display Pod

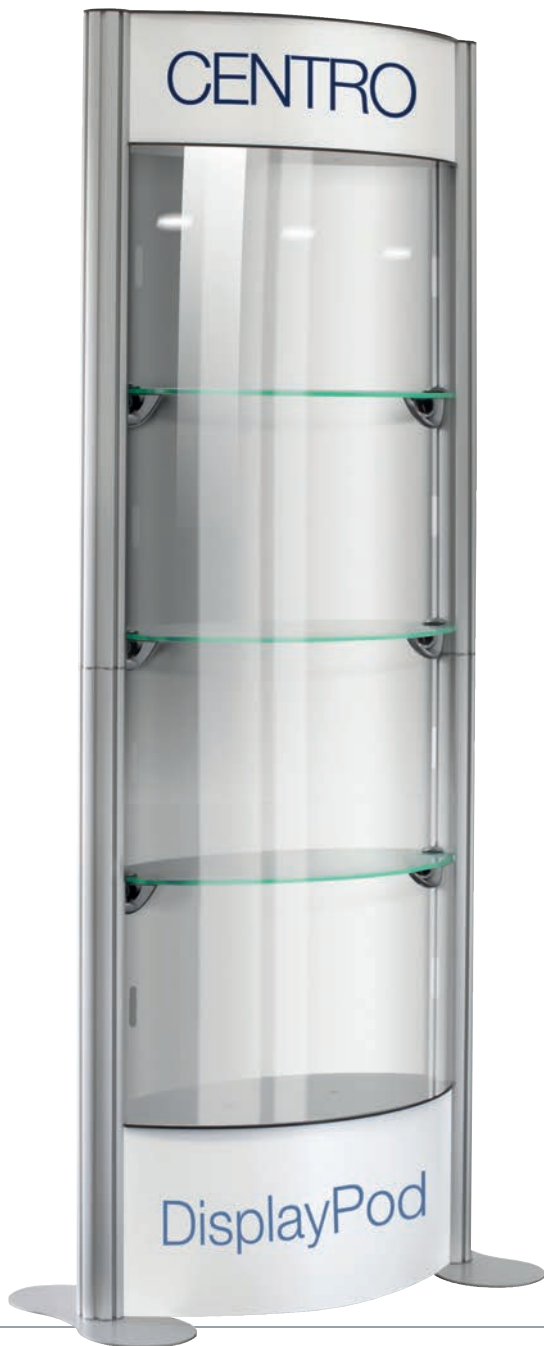

## Centro Display Pod

- Product code - CRSK/62/Black
- Innovative multifunctional product display unit which can be used in a variety of combinations including 'fully closed' dual aspect viewing
- Featuring ingenious RotrLink post/base & post/post connection
- The uniquely shaped 8mm thick 'green edge' acrylic shelves supported by chrome adjustable shelf brackets will each accept 12kg of evenly distributed product
- Generous individual display spaces - 616(w) x 300(d) x 360mm(h)
- Maximum overall stand dimensions - 868(w) x 380(d) x 2016mm(h)
- Includes 4 off 3mm Foamex header and base panels for promotional graphic display/corporate information
- All kits supplied dismantled for ease of transportation
- Supplied with 8 off 'glass clear' 2mm polycarbonate infill panels to shield and protect display products
- Individual panels can be replaced with printed graphics to create a distinctive visual backdrop
- 4mm hex key and cross head screw driver supplied for complete assembly
- Compatible with entire Centro range
- Ship safe durable carton measurements - 2 x 1020(w) x 500(d) x 240mm(h)
- Net weight - 27kg
- Packaged weight - 34kg (cartons)

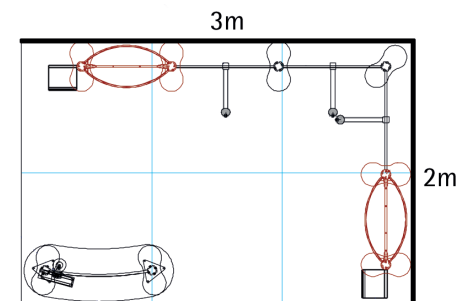

## Centro Wheeled Trolley Case

- Optional 2 off moulded wheeled trolley cases



## RotrLink System







- Display pod 'fully open' providing dual aspect viewing
- Allows products to be handled from both sides of stand



- Display pod 'open one side' providing single aspect viewing with option of graphic back drop panels
- Allows display products to be handled



- Display pod 'fully closed' providing single aspect viewing with option of graphic back drop panels
- Supplied viewing panels shield and protect display products



- Display pod 'creative use' of all possibilities providing unique double-sided option
- Allows products and graphics to be viewed in a variety of ways

# Centro Cable Display



Coloured acrylic features, neon blue, red and green or frost.



RotrLink System

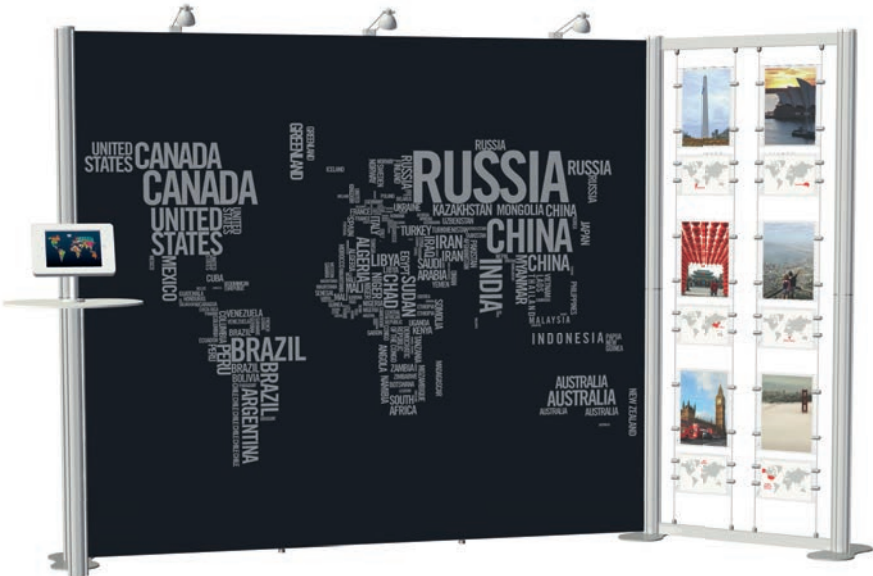

## Centro Suspended Poster Display

- Innovative multi-purpose freestanding modular poster display unit - six standard kits
- Features easily assembled Centro RotrLink post/base and post/post connection
- Premium quality double-sided clear acrylic display poster pocket holders
- Unique robust anodised aluminium posts, profiles and silver steel bases
- Chrome connectors, stainless steel hanging wire and hex keys supplied
- Range of coloured contemporary acrylic post caps and accessories
- All kits supplied dismantled for ease of transportation
- Compatible with the entire Centro range (as illustrated)
- Ship safe durable carton measurements - 1020(w) x 500(d) x 240mm(h)
- Maximum overall stand dimensions - 1006(w) x 380(d) x 2021mm(h)



## Clear Acrylic Holders

- Five standard sizes available - A5L, A4P, A4L, A3L and 500 x 700mm
- Thermoformed one piece acrylic to optimise pocket strength
- Ease of assembly



### Kit 1

- Product code - C1SP1/75
- 4 x A4 Portrait double-sided 2mm thick clear acrylic poster holders
- Packaged weight - 19kg (carton)



### Kit 2

- Product code - C1SP2/75
- 8 x A4 Portrait double-sided 2mm thick acrylic poster holders
- Packaged weight - 21kg (carton)

### Kit 3

- Product code - C1SP3/75
- 5 x A4 Landscape double-sided 2mm thick acrylic poster holders
- Packaged weight - 20kg (carton)



### Kit 4

- Product code - C1SP4/75
- 4 x A3 Landscape double-sided 2mm thick acrylic poster holders
- Packaged weight - 21kg (carton)

### Kit 5

- Product code - C1SP5/75
- 2 x 500 x 700mm Portrait double-sided 3mm thick acrylic poster holders
- Packaged weight - 29kg (2 x cartons)



### Kit 6

- Product code - C1SP6/75
- 6 x A4 Portrait and 6 x A5 Landscape double-sided 2mm thick acrylic poster holders
- Packaged weight - 22kg (carton)



# Centro Slatwall Display



## Centro Slatwall Display

- Product code - C1SK/75
- Innovative single-sided multifunctional product display
- Self-assembly display featuring ingenious RotrLink post connection
- Stylish inter-locking white slat wall panels (set of 5) - each 766(w) x 310mm(h)
- Slatwall visual area when assembled - 750mm(w) x 1540mm(h)
- Graphic display opportunity on spacer panel – visual area 750(w) x 350mm(h)
- Compatibility with the entire Centro range
- Wide range of slatwall accessories available
- All kits supplied dismantled for ease of transportation
- Maximum overall stand dimensions - 1006(w) x 380(d) x 2016mm(h)
- Ship safe durable carton measurements - 1020(w) x 500(d) x 240mm(h)
- Packaged weight - 23kg (carton)

Coloured acrylic features, neon blue, red and green or frost.



RotrLink System





### 10 Ball Sloping Arm

- Product code - SBSA 280
- 280mm
- Chromed steel



### Euro Prong Card Arm

- Product code - SEPA 200
- 200mm
- Chromed steel



### Single Prong Card Arm

- Product code - SSPA 150
- 150mm
- Chromed steel

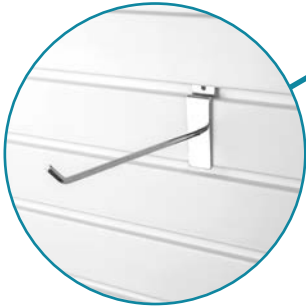

### Flat Product Shelf

- Product code - SFPS 100
- 100 x 300mm
- Clear acrylic 3mm



### Leaflet Holders

- A4 Product code - SLH/A4
- A5 Product code - SLH/A5
- 1/3 A4 Product code - SLH/DLE
- Clear acrylic 3mm

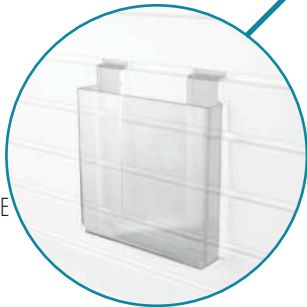

### Shoe Shelf

- Product code - SSSR 100
- Right facing - 100 x 250mm
- Clear acrylic 3mm

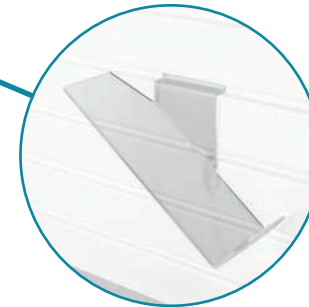

### Curved Product Shelf

- Product code - SCPS 150
- 150 x 150mm
- Clear acrylic 3mm

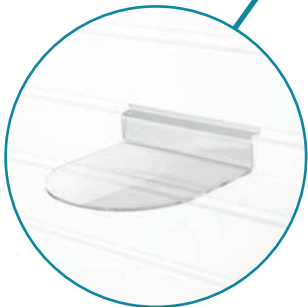

### Product Shelf Set

- Product code - SPSS 250
- Including brackets - 250 x 600mm
- Clear acrylic 4mm



Non – standard accessories on application

# Accessories

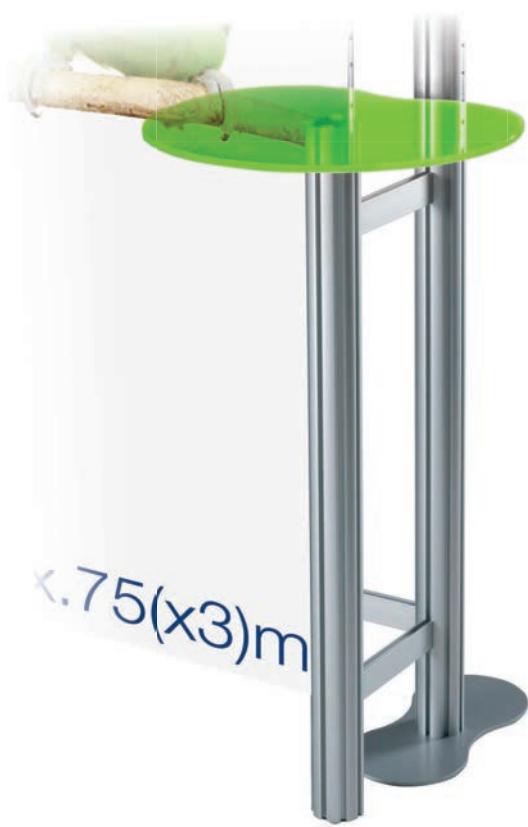

## Centro Podium Kit

- Product code - CPTS
- Ergonomically designed acrylic top available in neon blue, red and green or frost
- Contemporary design to enhance visual impact of modular display system
- Clamps securely to Centro system post in a variety of positions
- Podium top dimensions - 500(w) x 443mm(dia)

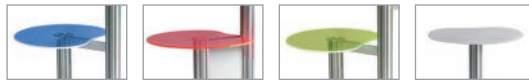

## Centro Counter Kit

- Product code - CRCC
- Elegant high quality anodised aluminium curved modular counter
- Freestanding display with pearl white laminate counter top supplied
- Featuring ingenious new RotrLink post/base connection
- Overall dimensions - 1092(w) x 440(d) x 1025mm(h)
- Net weight - 19.1kg
- Packaged weight - 23kg



## Brochure Holder Set

- Product code - CLPS
- Colour co-ordinated acrylic A4 portrait brochure holder
- Available in neon blue, green and red, or standard frost
- Thermoformed one piece acrylic to maximise strength
- Simple 'hook over' style fitting

- Product code - CTCT1
- Optional laminated folding top available in beech or black with padded bag

## Centro Wheeled Trolley Case

- Product code - CTC1
- Stylish and durable moulded plastic case with rubber wheels
- Detachable lid with moulded handle and 3 lockable latches
- Convenient side carry handle
- White lined tube - 254mm dia. x 980mm (holds 4 x 1990mm graphics)
- Overall dimensions - 520(w) x 440(d) x 1130mm(h)
- Internal dimensions - 460(w) x 360(d) x 912mm(h)
- Nominal net weight including tube without graphics - 8.9kg
- Converts to counter display with simple application of graphic wrap
- Quality assured - 12 months guarantee
- Packaged weight - 12kg





### Centro Door Frame

- Product code - CDKS/75
- Innovative 1900(h) x 750mm(w) hinged door design for 5 to 7mm thick rigid panels
- Modular anodised aluminium construction with door handle, quarter turn lock and 2 keys
- 4mm hex key and cross head screw driver supplied for complete assembly
- Compatible with the entire Centro range
- Low profile threshold door bar complies with Health & Safety requirements



### 4mm Hex Key

- Product code - CTH4
- High strength nylon handle
- Ergonomic handle for maximum grip and comfort



### Spotlight

- Product code - CSP2
- 50w silver low voltage spotlights
- Contemporary perforated lamp cover
- Vertically tilting head design
- In-line transformer and power lead 3m long



### Halogen Lamp

- Product code - CHL2
- 150w silver halogen lamp
- Stylish design with 360° pivoting head
- Power lead 3m long



### Quadrant Shelf Kit

- Product code - CQSK
- Stylish shelf with pre-assembled secure mounting bracket
- Self-select desired shelf position and height
- MDF shelf with membrane pressed durable coating available in grey or white
- Shelf dimensions 300mm(dia)
- Net weight - 1.2kg



### iPad Post Mounting Kit

- Product code - CiP/K5
- iPad holder and Centro interface mounting bracket supplied
- Enclosures in textured black or white finish
- Rotates 360°
- Overall holder dimensions
  - Portrait - 206(w) x 58(d) x 294mm(h)
  - Landscape - 294(w) x 58(d) x 206mm(h)
- Packaged weight - 3kg



### Screen Mounting Kit

- Product code - CSMK1
- Special expanding bracket clamp with heavy-duty screws to secure screen to post
- Uncomplicated assembly with 5mm hex key supplied
- Maximum screen size 22 inches - for the option of mounting larger screens see the Centro kits in AV section
- Screen not included

# Centro Audio Visual Solutions

*Stunning multimedia displays with huge power to engage*

When it comes to getting a brand noticed in a crowded space, video is without doubt one of the strongest mediums to use. We are all naturally attracted to movement and light so it is no surprise that the use of video across all types of marketing continues to grow at an astounding rate, while production costs drop by the day.

If you ever stop to look around at a crowded event, you will notice the stands attracting the lion's share of people's attention are almost always displaying engaging video content. By using just static printed graphics, it is usually very difficult for companies to explain their offering in the short time that new prospects give to decide whether to explore further, or walk away. An eye-catching video with entertaining content can give brands that extra time they need to get the message across clearly.

Our Centro multimedia range is capable of holding both 32" and 42" screens and are available in a range of different sizes and layout configurations. When dismantled the entire displays, including the screens, will fit into a series of practical, wheeled cases making these kits extremely portable display solutions with huge power to engage audiences.







**The Business  
Connective**  
North West

Expand your business at one of our many free business networking events and mingle with other entrepreneurs to help you grow your business.

Join today online for instant access to business connectivity tools.

[www.tbcnetworkevent.com](http://www.tbcnetworkevent.com)



[www.tbcnetworkevent.com](http://www.tbcnetworkevent.com)

# Centro Audio Visual Solutions



## Centro Multimedia Display

- Innovative modular graphic stands providing two screen height positions and universal mounting bracket for either 32" or 42" LED/LCD screen
- New unique RotrLink connection with anodised aluminium 8-way posts and matching silver steel bases
- Fewer component parts providing reduced assembly times - 4mm hex key supplied
- Compatible with entire Centro range
- Overall height without lighting 2019mm

RotrLink System



Coloured acrylic features, neon blue, red and green or frost.

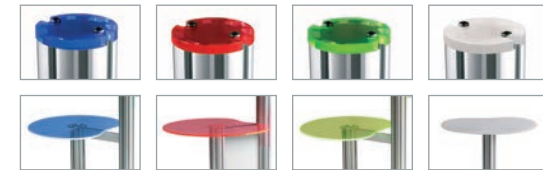

## Centro Wheeled Trolley Case

- Product code - CTC1x2
- Each kit requires two wheeled trolley cases



## Accessories Available

- Curved counter kit - white top only
- Podium set - table top colour to match post cap
- Brochure holder set - colour to match post cap
- Screen monitor and iPad mounting kits
- Choice of 50w or 150w lighting



### Kit 1

- Product code - CT1RK/95
- Podium table included for stand stability
- Footprint - 1206(w) x 521mm(d)
- Overall graphic dimensions - 1990(h) x 950mm(w)

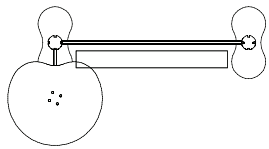

### Kit 2

- Product code - CT2RK/150
- Podium table included for stand stability
- Footprint - 1765(w) x 521mm(d)
- Overall graphic dimensions - 2 x 1990(h) x 750mm(w)

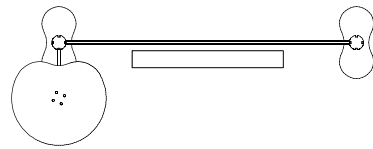

### Kit 3

- Product code - CT3RK/245
- Footprint - 2885(w) x 518mm(d)
- Overall graphic dimensions - centre panel 1 x 1990(h) x 950mm(w) and inner curve panels 2 x 1990(h) x 750mm(w)

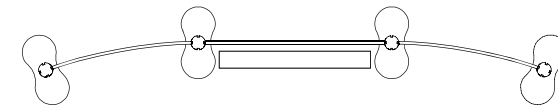

### Kit 4

- Product code - CT4RK/285
- Footprint - 3254(w) x 380mm(d)
- Overall graphic dimensions - centre & outer panels 3 x 1990(h) x 950mm(w)

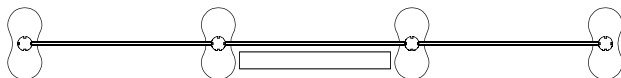

### Kit 4 Alternative Layout

- Footprint - 2652(w) x 1106mm(d)
- Overall graphic dimensions - centre & outer panels 3 x 1990(h) x 950mm(w)

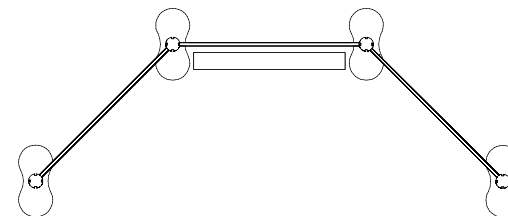

# Centro Self-build Exhibition Stands

*Flexible and portable with countless possible configurations*

When you are looking for a flexible solution that bridges the gap between portable displays and custom built stands, look no further than our range of modular self-build stands. These displays can be reused, reconfigured and are easily transportable – making them the perfect choice for companies that are looking for a cost-effective display that delivers big impact and an even bigger return on investment.

The beauty of the modular range is that the display can develop and grow to suit an expanding company with changing needs. The built-in flexibility means that stand components can easily be added to, or removed, to create a new layout to suit whichever space is needed. It is quite possible to use the same display at small regional shows as well as larger national and even international events and if the graphics are replaced with new branding and messaging, it's possible to have a fresh new look to your stand whenever you so desire.

On the pages that follow you will see some example layouts which start to show the many different configurations that are achievable using our range. To build the perfect display, you have the option of integrating lighting, shelving, podium tables, slat walling, counter units and even iPad stands into your stand design. All components are built to the high standards you'd expect and the entire range is backed up by our 5 year guarantee.





C17 CAMBRIC SYSTEMS LIMITED

C17 CAMBRIC SYSTEMS LIMITED

### SAFER PATIENT CARE WITH INSTANT ACCESS TO CRITICAL INFORMATION

- ▶ WIRELESS HANDOVERS
- ▶ TASK MANAGEMENT
- ▶ EARLY WARNING SCORES
- ▶ PATIENT TRACKING LISTS
- ▶ WARD BOARDS
- ▶ ADMISSION BOARDS

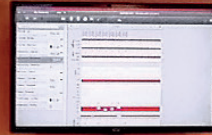

CORTIX<sup>®</sup>  
DEMO POINT

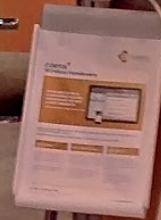
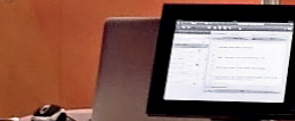

CORTIX<sup>®</sup>  
DEMO POINT

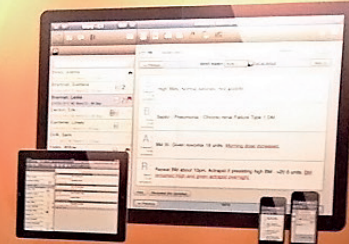

CORTIX<sup>®</sup>

- A NEW CONCEPT IN PATIENT SAFETY
- ▶ BETTER DECISIONS
  - ▶ FASTER TREATMENT
  - ▶ EARLIER DISCHARGE

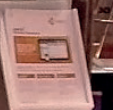



# Self-build Exhibition Examples

Centro components are made from high quality aluminium and the quality of the RotrLink twist and lock technology ensures the exhibition system can be used continually whilst retaining it's strength, enabling stand builds at various heights. Examples illustrated are at standard 2m high.

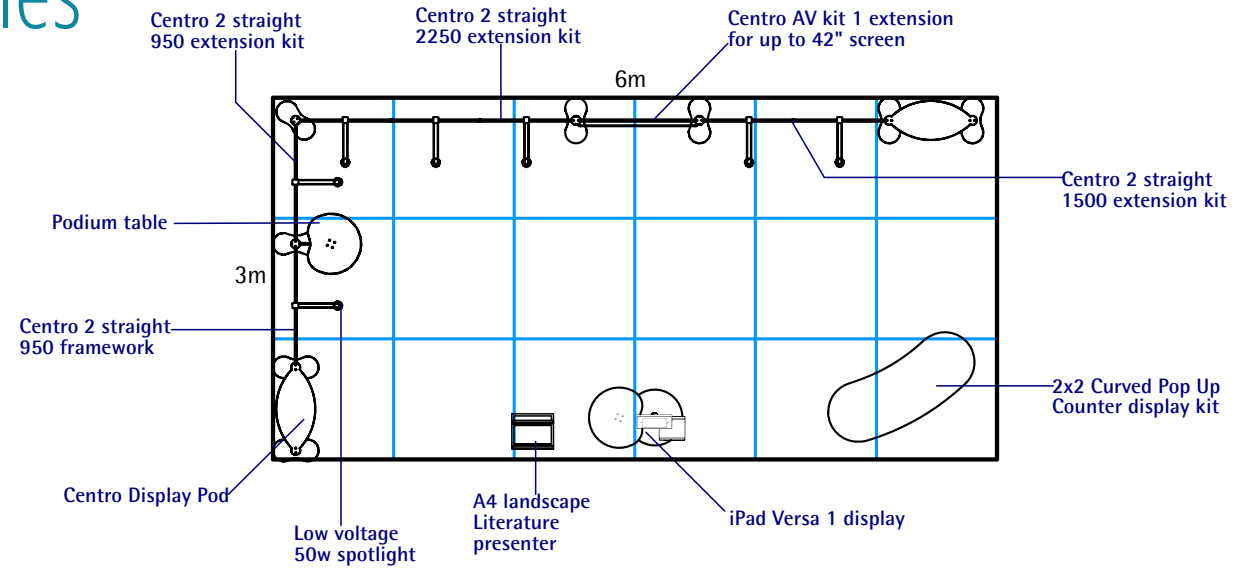

C6x3-2a



C3x2-1a



C3x3-2a



C3x2-2a



C3x2-2b



C3x3-1a



C4x3-2a

C4x3-1a







C4x2-2a



C4x3-2b



C5x2-2a



C5x3-2a



C5x4-2a



C6x3-1a



C9x4-3a



**Mirage Display Limited** | Unit 11 Marsland Street Industrial Estate | Hazel Grove | Stockport | SK7 4ER  
www.miragedisplay.co.uk | enquiries@miragedisplay.co.uk | 0161 482 7997