

Modular Display System/**Centro** 2 Curved



CENTRO 2 Curved - Modular Display System

- Designed for a visually-seamless magnetic graphic display
- Innovative modular display system
- Contemporary neon acrylic features
- Unique, robust anodised aluminium construction
- Requiring only a single hex bit for complete assembly
- 4mm hex key or power tool kit supplied
- Shaped silver base plate to maximise stability
- Overall height without lighting 2019mm
- Quality assured – 5 year guarantee

Modular Display System/**Centro** 2 Curved

Available in 3 widths

- Graphic widths - 750mm, 1500mm and 2250mm



C2KC/75

C2KC/150

C2KC/225

Specifications

Centro 2 Curved 750mm (C2KC/75)

- Weight with wheeled trolley case 31kg
- Maximum footprint 1263mm x 378mm

Centro 2 Curved 1500mm (C2KC/150)

- Weight with wheeled trolley case 33kg
- Maximum footprint 2007mm x 393mm

Centro 2 Curved 2250mm (C2KC/225)

- Weight with wheeled trolley case 35kg
- Maximum footprint 2695mm x 567mm

Overall height of all Centro kits is 2015mm.
The above weight figures include the kit, wheeled trolley case and packaging.

Modular Display System/**Centro** 2 Curved

Post caps available in various colours

- Range of coloured neon acrylic features - blue, green, red and standard frost



CENTRO wheeled trolley case

- Compact and durable moulded plastic case and lid
- Base fitted with Rubber Wheels
- Moulded lid handle with additional side carry handle
- 3 lid latches with lockable facility
- White lined graphics tube 254mm dia. x 980mm (can hold 4 x 1990mm drops)
- Internal elasticated product retaining strap
- Overall case dimensions 520mmW x 440mmD x 1130mmH
- Net weight 9.0kg
- Quality assured - 12 months guarantee



POWER tool kit

- Versatile Cordless Screwdriver with variable torque settings
- Kit contains 1x 4mm hex bit for complete Centro assembly
- 1x spare manual 4mm hex key for emergency use only
- 3.6v Lithium-ion battery
- Compact carry container 200mmW x 172mmH x 117mmD
- Net weight 1.2kg

Supplied with C2KC/150 and C2KC/225 as standard.



4mm Hex Key

- High strength nylon handle
- Ergonomic handle for maximum grip and comfort

Supplied with C2KC/75 as standard.

CENTRO 2 Curved (750mm) Graphic Specification

1990mm x 750mm

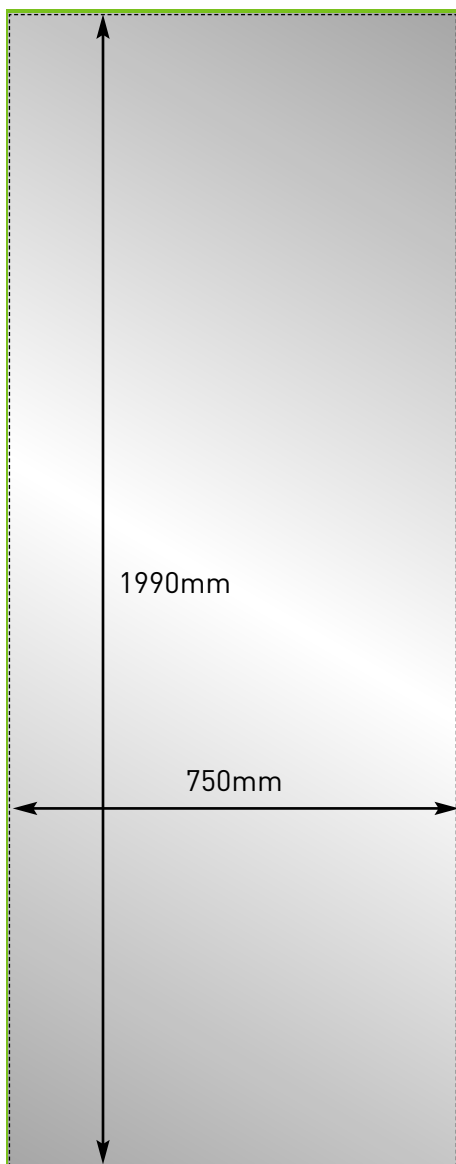

Visible graphic area
1990mmH x 750mmW

Finished print size
1990mmH x 750mmW

Image bleed area
2010mmH x 770mmW
(10mm to all outer edges of the design)



CENTRO 2 Curved (1500mm) Graphic Specification

1990mm x 1500mm

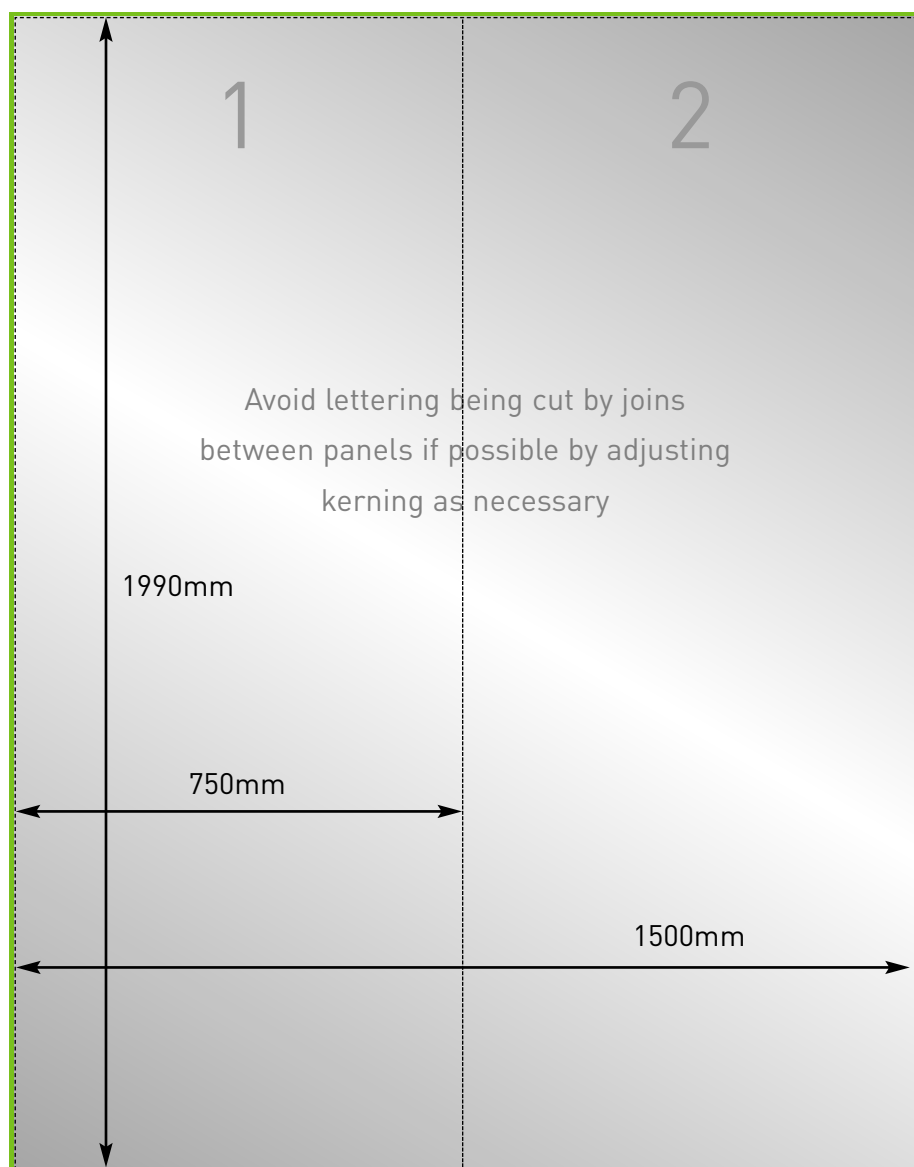

Visible graphic area
1990mmH x 1500mmW

Finished print size
1990mmH x 1500mmW
(2 panels 750mm width)

Image bleed area
2010mmH x 1520mmW
(10mm to all outer edges of the design)



CENTRO 2 Curved (2250mm) Graphic Specification

1990mm x 2250mm

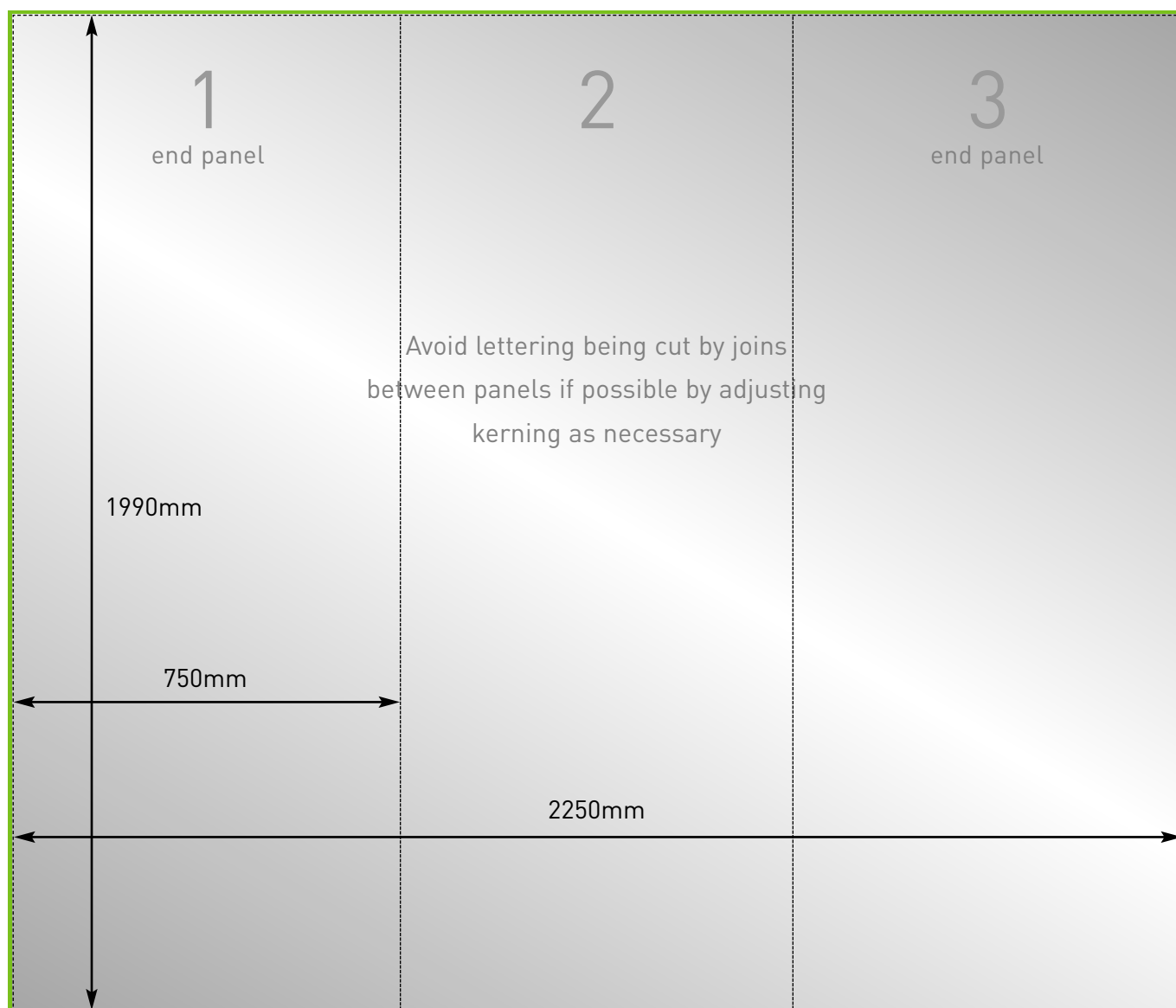

Visible graphic area
1990mmH x 2250mmW

Finished print size
1990mmH x 2250mmW
(3 panels 750mm width)

Image bleed area
2010mmH x 2270mm
(10mm to all outer edges of the design)



Centro 2 Assembly Instructions Straight and Curved (with spacer bars)



1

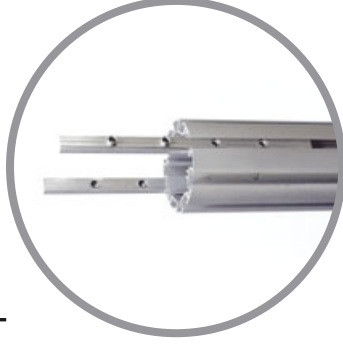

Stand base on the ground.
Loosen grub screws and slide both connector bars half way out of groove and retighten.
Repeat for other base post.

Note: Base plates pre-assembled on kits supplied in carry bag only.



2

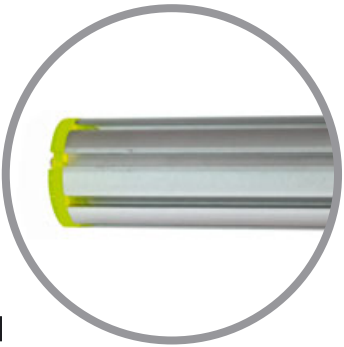

The upper 8-way post end cap has two notches which should align with the connector bar grooves shown in stage 4.

3

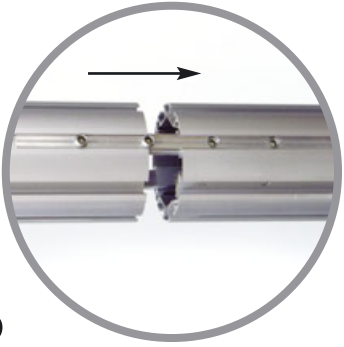

Join posts and tighten the grub screws to make assembly secure. Repeat for other base post.



4

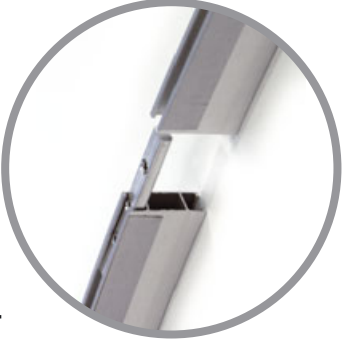

The graphic rails are joined in the same manner as the posts, by loosening connector bars, sliding in between rails and retightening. Ensure graphic fitting strips are aligned.



5

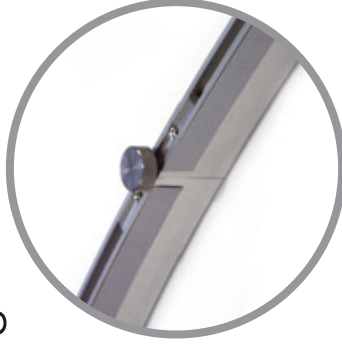

The adjustable feet should be screwed into the horizontal 750mm rails used at the bottom of the system. Note position of graphic fitting strip.



6

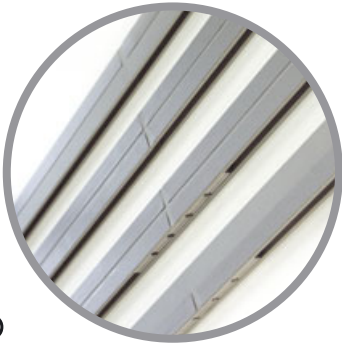

The side and middle* straight vertical 950mm graphic rails should now be assembled. Note position of graphic fitting strips.

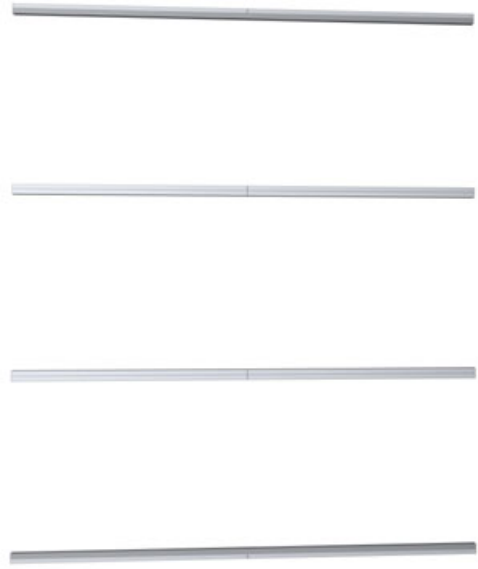

7



Slot spacer bars into assembled post approx 150mm from top and base. Tighten the grub screws to lock into place.



8



Slot outer vertical rails onto spacer bars leaving space at bottom for the horizontal graphic rail. Secure in place by tightening grub screws. Single strip line should be on the edge closest to post when viewed from front.



9



Connect bottom horizontal rail to both vertical rails and tighten grub screws as before. Leave top horizontal rail until all verticals are in place. They will balance.

11



Slot top horizontal rail onto all vertical rails and tighten grub screws.

10



Connect middle rail(s)* to the bottom rail. The middle rails have a double graphic fitting strip on them.

12

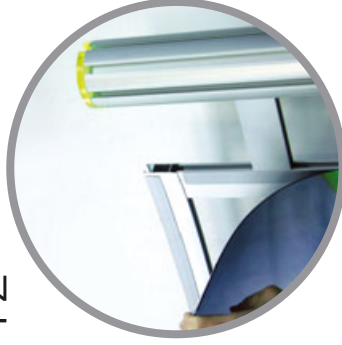

Affix graphics to the fitting strip starting from the top and side, working across the completed system.

Centro 2 Assembly Instructions

Straight and Curved (no spacer bars)



1

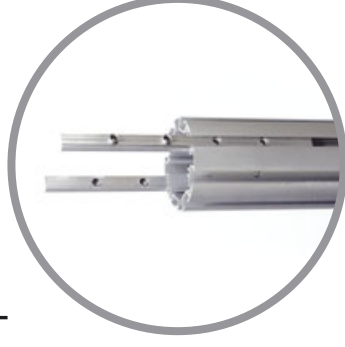

Stand base on the ground. Loosen grub screws and slide both connector bars half way out of groove and retighten. Repeat for other base post.

Note: Base plates pre-assembled on kits supplied in carry bag only.

2

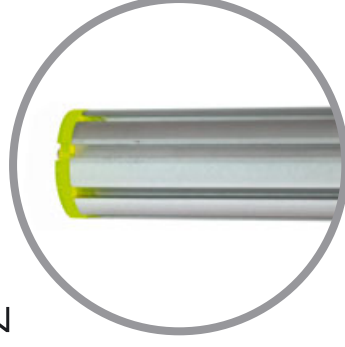

The upper 8-way post end cap has two notches which should align with the connector bar grooves shown in stage 3.

3

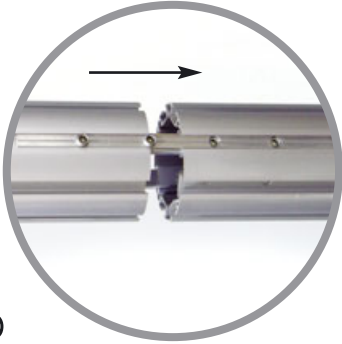

Join posts and tighten the grub screws to make assembly secure. Repeat for other base post.



4

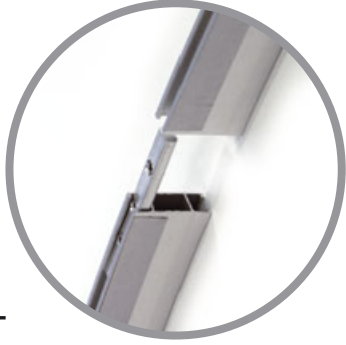

The graphic rails are joined in the same manner as the posts, by loosening connector bars, sliding in between rails and re-tightening. Ensure graphic fitting strips are aligned.



5

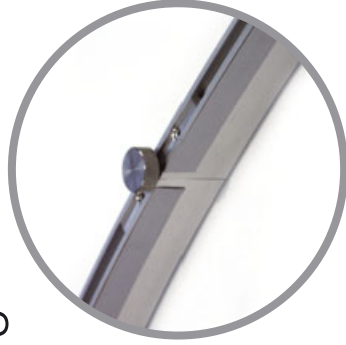

The adjustable feet should be screwed into the horizontal 750mm rails used at the bottom of the system. Note position of graphic fitting strip.



6

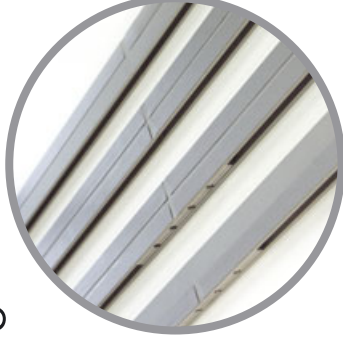

The side and middle* straight vertical 950mm graphic rails should now be assembled. Note position of graphic fitting strips.

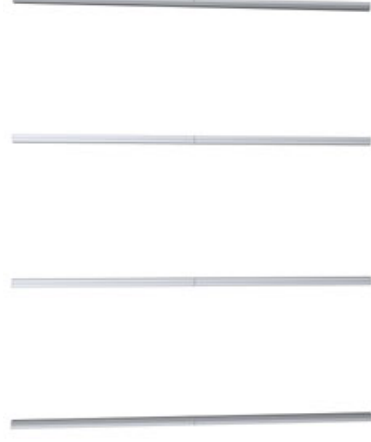



7

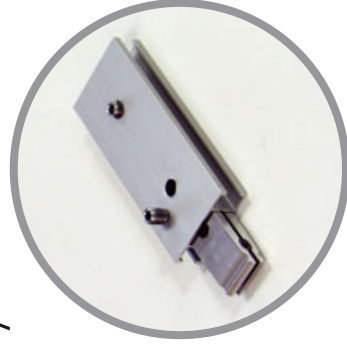

Remove four internal clamps from the spacer bars by removing grub screw and sliding out.

8



Insert internal clamps into both ends of the horizontal rails and secure by inserting grub screw and tightening (not fully).

9



Connect the bottom horizontal rail to the two posts and tighten grub screws as before. Leave top rail until all verticals are in place. They will balance.

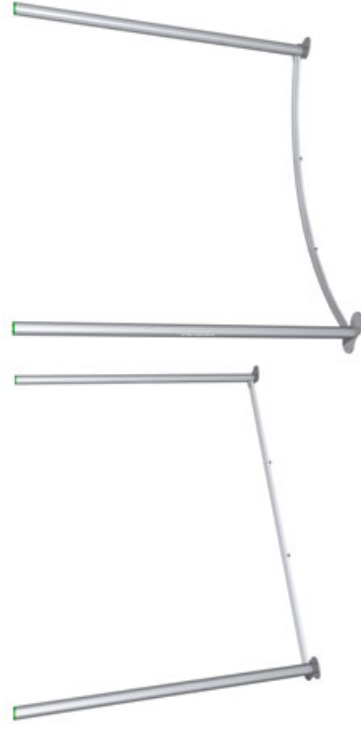

10



Connect side vertical rails to the bottom horizontal rail. The side vertical rails have one run of tape on them. Strip should be nearest the post when viewed from the front.

11



Connect middle rail(s)* to the bottom rail and tighten grub screws. The middle rails have a double graphic fitting strip on them. They will balance.

12



Slot top horizontal rail onto all vertical rails and tighten grub screws.



13

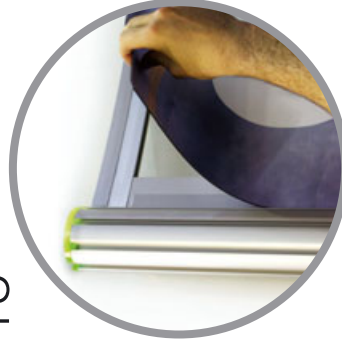

Affix graphics to the fitting strip starting from the top and side, working across the completed system.

